

Nominal Size W x H x D (in)	Actual Size W x H x D (in)	Part Number	Capacity (CFM)	Resistance (in W.G.)	Media Area (sq ft)	Carton Qty	Weight per Carton (lbs)
24 x 24 x 4	23-3/8 x 23-3/8 x 3-3/4	120-634-2424	2000	0.20	68	3	18
25 x 20 x 4	24-3/8 x 19-3/8 x 3-3/4	120-634-2520	1750	0.20	59	3	16
25 x 18 x 4	24-3/8 x 17-3/8 x 3-3/4	120-634-2518	1575	0.20	53	3	15
25 x 16 x 4	24-3/8 x 15-3/8 x 3-3/4	120-634-2516	1400	0.20	47	3	13
24 x 20 x 4	23-3/8 x 19-3/8 x 3-3/4	120-634-2420	1675	0.20	58	3	15
20 x 24 x 4	19-3/8 x 23-3/8 x 3-3/4	120-634-2024	1675	0.20	57	3	15
20 x 20 x 4	19-3/8 x 19-3/8 x 3-3/4	120-634-2020	1400	0.20	48	3	13
18 x 24 x 4	17-3/8 x 23-3/8 x 3-3/4	120-634-1824	1500	0.20	53	3	14
18 x 20 x 4	17-3/8 x 19-3/8 x 3-3/4	120-634-1820	1250	0.20	44	3	12
16 x 25 x 4	15-3/8 x 24-3/8 x 3-3/4	120-634-1625	1400	0.20	48	3	13
16 x 24 x 4	15-3/8 x 23-3/8 x 3-3/4	120-634-1624	1350	0.20	46	3	12
16 x 20 x 4	15-3/8 x 19-3/8 x 3-3/4	120-634-1620	1125	0.20	38	3	10
16 x 16 x 4	15-3/8 x 15-3/8 x 3-3/4	120-634-1616	900	0.20	31	3	9
14 x 20 x 4	13-3/8 x 19-3/8 x 3-3/4	120-634-1420	975	0.20	34	3	10
12 x 24 x 4	11-3/8 x 23-3/8 x 3-3/4	120-634-1224	1000	0.20	34	6	10
12 x 20 x 4	11-3/8 x 19-3/8 x 3-3/4	120-634-1220	850	0.20	28	6	8

Standard Construction:

1. Synthetic Media
2. Hotmelt Adhesive Media Separators
3. HIPS Frame

Specifications:

1. Efficiency: MERV 13 per ASHRAE Standard 52.2-2017
2. Final Resistance: 1.5" w.g.
3. Rated Velocity: 500 FPM
4. Classified per UL Standard 900
5. Maximum Operating Temperature: 150 degrees F (66 C)
6. Tolerance: Height & Width - +/- 1/8"
7. Tolerance: Depth - +/- 1/16"

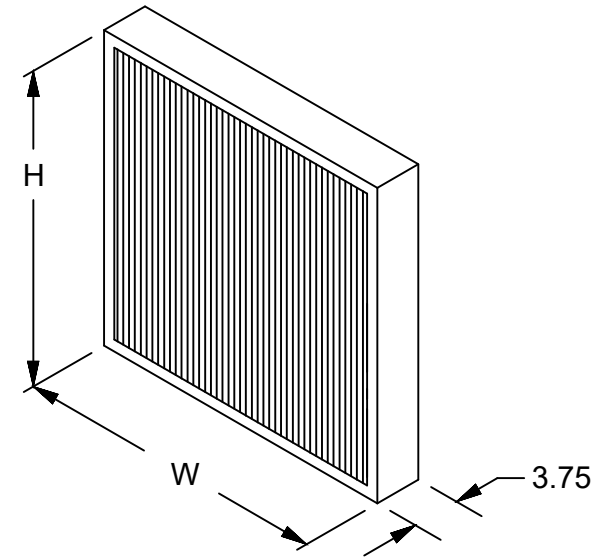

**Micromax PL4S
MERV 13**

REV
LTR

REVISION

BY /
DATE

8401 Air Commerce Drive - Louisville KY 40219
Phone: (502) 634-4796 FAX: (502) 637-2280

Drawn By: Brent Chamberlain
Date: August 17, 2023

Revision